

Handle - SC881A

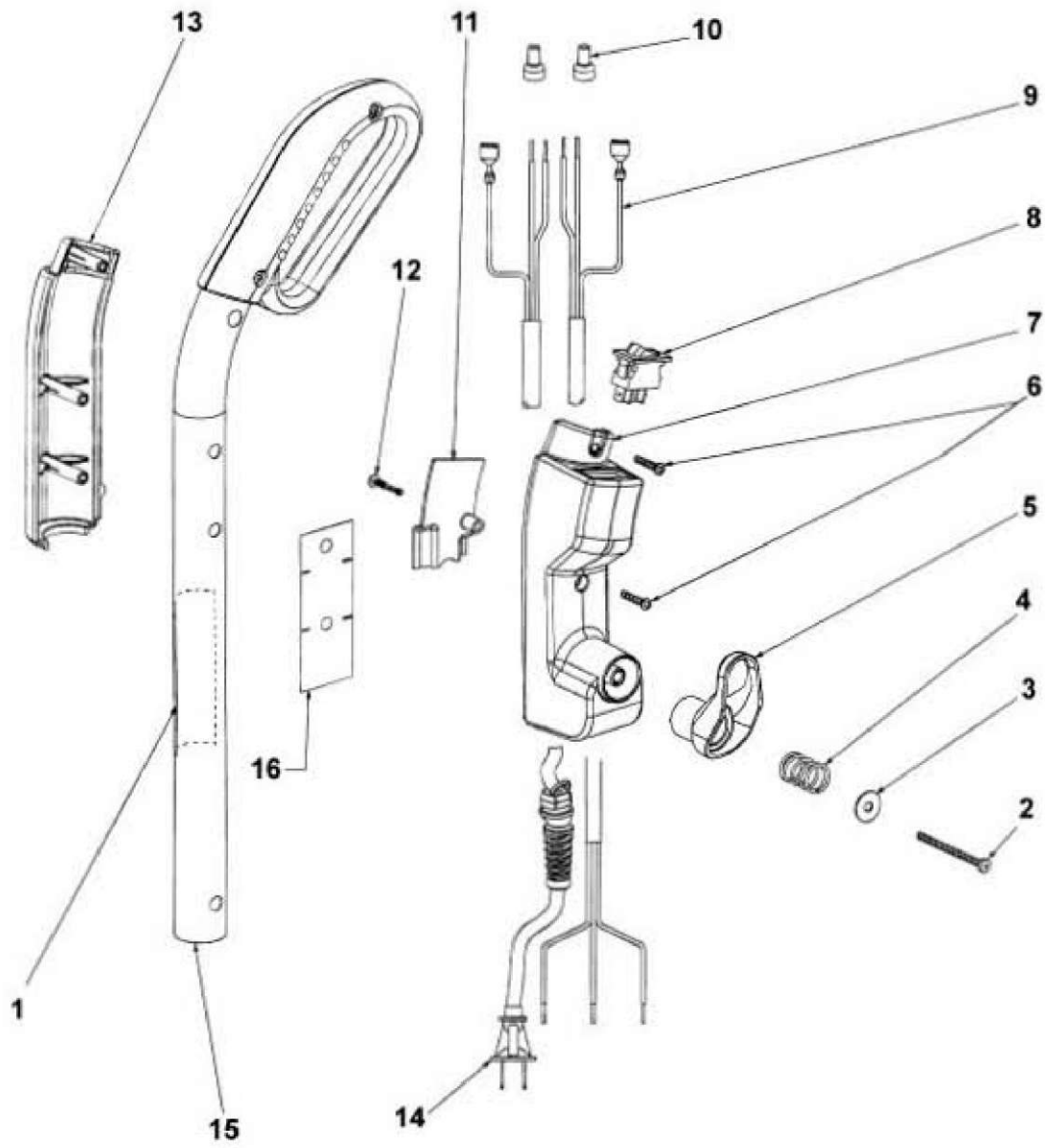

Handle - SC881A

Ref #	Part	Description	Comments	Qty
1		Label		
2	53238-18	SCREW PACKAGE		
3	60946	WASHER - PACKAGED		
4	60945	SPRING - PACKAGED		
5	28316-355N	RETAINER - CORD		
6	53197-1	SCREW PACKAGE		
7	76643-355N	HOUSING - SWITCH (LH)		
8	28073A	SWITCH - ROCKER		
9	76767	UPPER CORD ASSY.		
10	60192-1	WIRE SPLICE 5		
11	59741 -316N	SHIELD - WIRING		
12	60947	SCREWS - PACKAGED		
13	76644-355N	HOUSING - SWITCH (RH)		
14	36577A-23	SUPPLY CORD ASSY		
15	15774-2SV	UPRIGHT HANDLE & GRIP ASS		
16	76644-355N	HOUSING - SWITCH (RH)		
17	76224	CORD - EXTENSION	Extension cord not pictured	
18	76225-355N	CORD LOCK	Extension cord lock not pictured	
	13154B-355N			
	12637-8	TUBE - HANDLE (LOWER)		

## Base and Hood - SC881A

**54097-5 HOOD & NAMEPLATE ASS'Y.**  
**77147 NAMEPLATE**

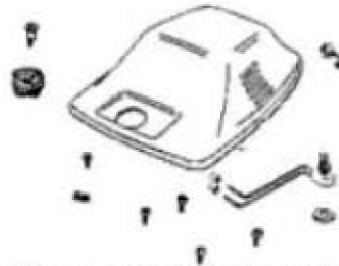

**56383-1SV AIR INLET DUCT ASS'Y. (R.H.)**  
**49052-3 FOAM TAPE**

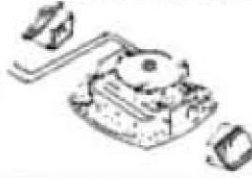

**56382-1SV AIR INLET DUCT ASS'Y.**  
**49052-3 FOAM TAPE**

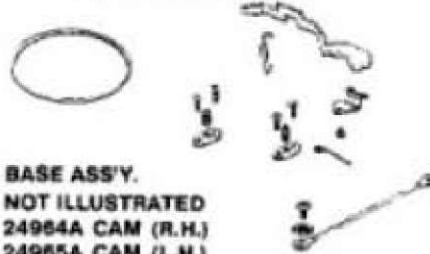

**53474-7 BASE ASS'Y.**  
**NOT ILLUSTRATED**  
**24964A CAM (R.H.)**  
**24965A CAM (L.H.)**  
**53118 RIVET-CAM PKG. 10 2 USED**  
**53133 WASHER PKG. 10 2 USED**

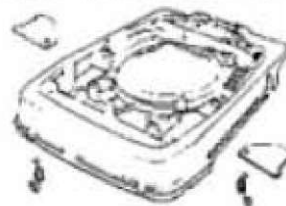

**52334 FAN CHAMBER REPLACEMENT KIT (INCLUDES)**  
**30517 MOTOR SEAL GASKET**  
**13770-1 FAN CHAMBER COVER**  
**53238-14 SCREW**  
**PKG. 10 2 USED**



## Base and Hood - SC881A

Ref #	Part	Description	Comments	Qty
1	54097-5	HOOD & NAMEPLATE ASSY - P		
2	77147			
3	53143	SCREW PACKAGE (10)		
4	38053-2	KNOB ASSEMBLY		
5	53228-2	SCREWS - PACKAGE 10		
6	53160	CABLE CLAMP PACKAGE		
7	53238-13	SCREW PACKAGE		
8	53238-14	SCREW PACKAGE		
9	53214-1	WIRE SPLICE 5		
10	53102	LOCKWASHER PACKAGE (10)		
11	56383-1SV	DUCT ASSEMBLY (R)		
12	49052-3	TAPE - FOAM		
13	54352-15	MOTOR ASSEMBLY - PACKAGED		
14	56382-1 SV	DUCT ASSEMBLY (L)		
15	56382-1 SV	DUCT ASSEMBLY (L)		
16	49052-3	TAPE - FOAM		
17	30517	GASKET - MOTOR SEAL		
18	24834A-3	PEDAL - FOOT		
19	53097	SPRING - FOOT PEDAL PKG (		
20	37034	SPRING - ADAPT RETAINER		
21	53140	CLAMP & SCREW ASSY PKG		
22	53238-11	SCREW PACKAGE		
23	54173-1	WIRE ASSY (GROUNDING)		
24	53474-7	BASE ASSEMBLY - CARTONED		
25	53213-4	NUTS - PACKAGE 10		
26	54177	WIRE & TERMINAL ASSY		
27	24964A-1	CAM (RIGHT)		
28	24965A-1	CAM (LEFT)		
29	53118	RIVET - SHOULDER PACKAGE		
30	53133	STL WASHERS-PKG (48495 (NLA)		
31	36263	COVER - WHEEL		
32	53117	SPRING - HOOD PACKAGE (10		
33	53474-7	BASE ASSEMBLY - CARTONED		
34	52334	FAN CHAMBER REPLACEMENT K		
35	13770-1	COVER - FAN SCROLL		
36	13770-1	COVER - FAN SCROLL		

Furniture Guard and Brush Roll - SC881A



**37234-3 WHEEL & AXLE ASS'Y. (INCLUDES)**

- 53110 WHEEL WASHER  
PKG. 10 2 USED
- 37183 REAR AXLE
- 53121 PUSHNUT USED  
PKG. 10 2

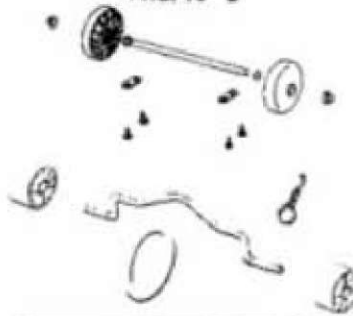

**NOTE**  
PT. NO. 53270  
DISTURBULATOR ASS'Y.  
INCLUDES\*

- 13236-3 DISTURBULATOR TUBE
- 52282-4 BRISTLE STRIP ASS'Y.
- 49899 FELT WASHER
- 54256 BEARING RETAINER  
PKG. 2 2 USED
- 25057A DISTURBULATOR CAP
- 53158 LOCK NUT  
PKG. 10 2 USED
- 53184 KLIPRING  
PKG. 10 2 USED
- 25937 SHAFT



**25922-1 BOTTOM PLATE ASS'Y. (INCLUDES)**  
48538 FOAM TAPE



Furniture Guard and Brush Roll - SC881A

Ref #	Part	Description	Comments	Qty
1	37234-3			
2	53110	WASHER - WHEEL PACKAGE (1		
3	37183	AXLE - REAR		
4	53121	PUSH NUT PACKAGE (10)		
5	76334	FURNITURE GUARD ASSEMBLY		
6	76369-1	REAR WHEEL OVERMOLD		
7	55535-2	AXLE CLAMP - PACKAGED		
8	53238-11	SCREW PACKAGE		
9	53076-2	SPRING & AXLE PACKAGE (6)		
10	35859A-1	WHEEL - FRONT		
11	35947A	AXLE - FRONT		
12	30563A	BELT-DISTURBULATOR DRIVE		
13	53270	DISTURBULATOR ASSEMBLY		
14	53158	LOCK NUT PACKAGE		
15	26059A	CAP - COVER		
16	26057A	CAP - DISTURBULATOR		
17	54256	BRG & RET ASSY		
18	53184	KLIPRING PACKAGE		
19	25937	SHAFT - DISTURBULATOR		
20	52282-4	BRISTLE STRIP PACKAGE		
21	13236-3	TUBE - DISTURBULATOR		
22	25922-1	BOTTOM PLATE ASSEMBLY		
23	46538-4	TAPE - FOAM		

Motor - SC881A

54352-15 MOTOR ASSY



54395-4 ARM, FAN & BEARING ASSY

- 53088-2 BEARING
- 30474A FAN

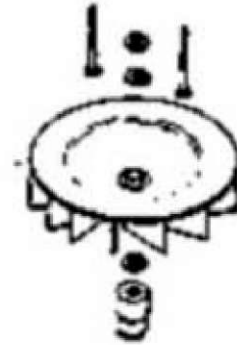

54169-1 MOTOR BASE ASSY

- 54412 BEARING & RETAINER ASSY
- 53088-1 BEARING
- 53187-1 RIVET

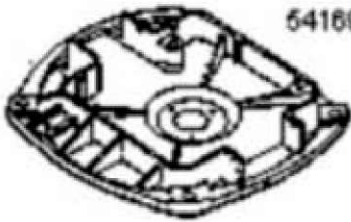

Motor - SC881A

Ref #	Part	Description	Comments	Qty
1	54352-15	MOTOR ASSEMBLY - PACKAGED		
2	53219-2	SCREWS - PACKAGE 10		
3	53213-4	NUTS - PACKAGE 10		
4	53222-3	LOCKWASHERS- PACKAGE 10		
5	30478	MOTOR BRUSH ASSEMBLY		
6	53138	SCREWS - PACKAGE 10		
7	54396	MOTOR COVER ASSEMBLY - LA		
8	20217E	RETAINER - UPPER BEARING		
9	53441-2	FIELD ASSEMBLY - PACKAGED		
10	56802-2	TIE - CABLE (PURCHASED)		
11	54395-4	ARMATURE, FAN & BRG ASSY-		
12	53088-2	BALL BEARINGS use 53088-4		
13	30474A	FAN - MOTOR COOLING		
14	53142	SCREW PACKAGE (10)		
15	53188-1	WASHER PACKAGE		
16	53148	WASHER - FAN PACKAGE (10)		
17	77247-355N	FAN BLOWER - MOTOR		
18	37012-2	PULLEY - MOTOR DRIVE		
19	54169-1	MOTOR BASE ASSEMBLY		
20	54412-2	BEARING RETAINER ASSY-W/L		
21	53088-1	BALL BEARING - PACKAGE		
22	53187-1	RIVET PACKAGE		



Bag - SC881A

**54174-1 BAG ADAPTER  
48282 GASKET  
48748 WASHER  
48749 RIVET**



**49461B-3 HARDWARE PKG. (INCLUDES)  
1-LOWER CORD RETAINER  
2-HDLE. SCREW ASS'Y.**

Bag - SC881A

Ref #	Part	Description	Comments	Qty
1	54174-1	ADAPTER - BAG		
2	48282	GASKET - BAG ADAPTER		
3	48748	WASHER		
4	48749	PACKAGE - RIVET		
5	49461 B-3	HARDWARE PKG - COMM UPRIG		
6	30599D-10	CLIP - BAG		
7	47722	SPRING - BAG		
8	54582-4	BAG ASSEMBLY - PACKAGED		